

PS-22

Canadian Model
AEP Model
UK Model



Canadian Model

Cartridge is not supplied with this turntable system.

FULL AUTOMATIC STEREO TURNTABLE SYSTEM

SPECIFICATIONS

GENERAL

Power Requirements: 120 V ac, 60 Hz (Canadian model)
110, 120, 220, or 240 V ac adjustable,
50/60 Hz (AEP, UK model)

Power Consumption: 6 W

Dimensions: Approx. 446 (w) x 140 (h) x 374 (d) mm
17½ (w) x 5½ (h) x 14¾ (d) inches

Weight: Approx. 7.1 kg, 15 lb 10 oz (net)
Approx. 8.1 kg, 17 lb 14 oz (in shipping carton)

Platter: 32.6 cm (12¾ inches) dia.
Aluminum-alloy diecast

Motor: DC servo-controlled motor (brushless and slotless)

Drive System: Direct drive

Speeds: 33⅓, 45 rpm

Pitch Control Range: ± 4 %

Wow and Flutter: 0.03 % (WRMS)
± 0.045 % (DIN)

S/N Ratio: 70 dB (DIN-B)

TO NEARM

Type: Statically balanced, universal

Pivot-to-Stylus Length: 216.5 mm, 8½ inches

Overall Arm Length: 300 mm, 11¾ inches

Overhang: 16.5 mm, ¾ inches

Tracking Error: +3°, -1°

Tracking-Force Adjustment Range: 0 - 3 g

Shell Weight: 7.5 g

Cartridge Weight Range: 4 - 12 g

— Continued on next page —

SAFETY-RELATED COMPONENT WARNING!!
COMPONENTS IDENTIFIED BY SHADING ON THE SCHEMATIC DIAGRAMS AND IN THE PARTS LIST ARE CRITICAL TO SAFE OPERATION. REPLACE THESE COMPONENTS WITH SONY PARTS WHOSE PART NUMBERS APPEAR AS SHOWN IN THIS MANUAL OR IN SUPPLEMENTS PUBLISHED BY SONY.

SONY®

SERVICE MANUAL

CARTRIDGE (VL-32G) (AEP, UK model)

- Type: Moving magnet type
- Frequency Range: 10 — 30,000 Hz
- Channel Separation: 25 dB (1 kHz)
- Output Voltage: 3 mV (1 kHz, 5 cm/sec, 45°)
- Load Impedance: 50 k Ω
- Tracking Force: 1.5 — 2.5 g (2 g recommended)
- Stylus: Sony ND-134G
(Conical 0.5 mil diamond)
- Weight: 5.5 g

● **MODEL IDENTIFICATIONS**

— Specification Label —

Canadian model

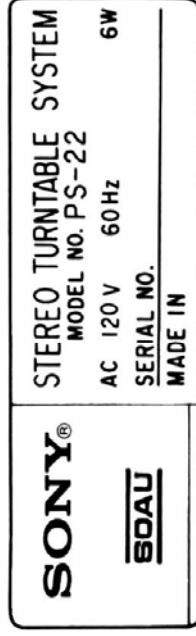

AEP, UK model

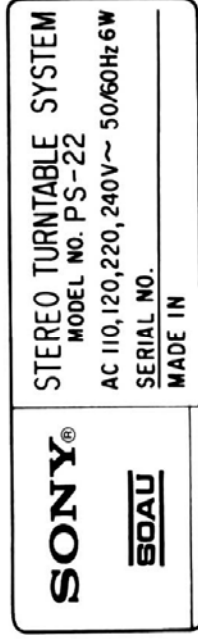

SECTION 1 OUTLINE

1-1. BLOCK DIAGRAM

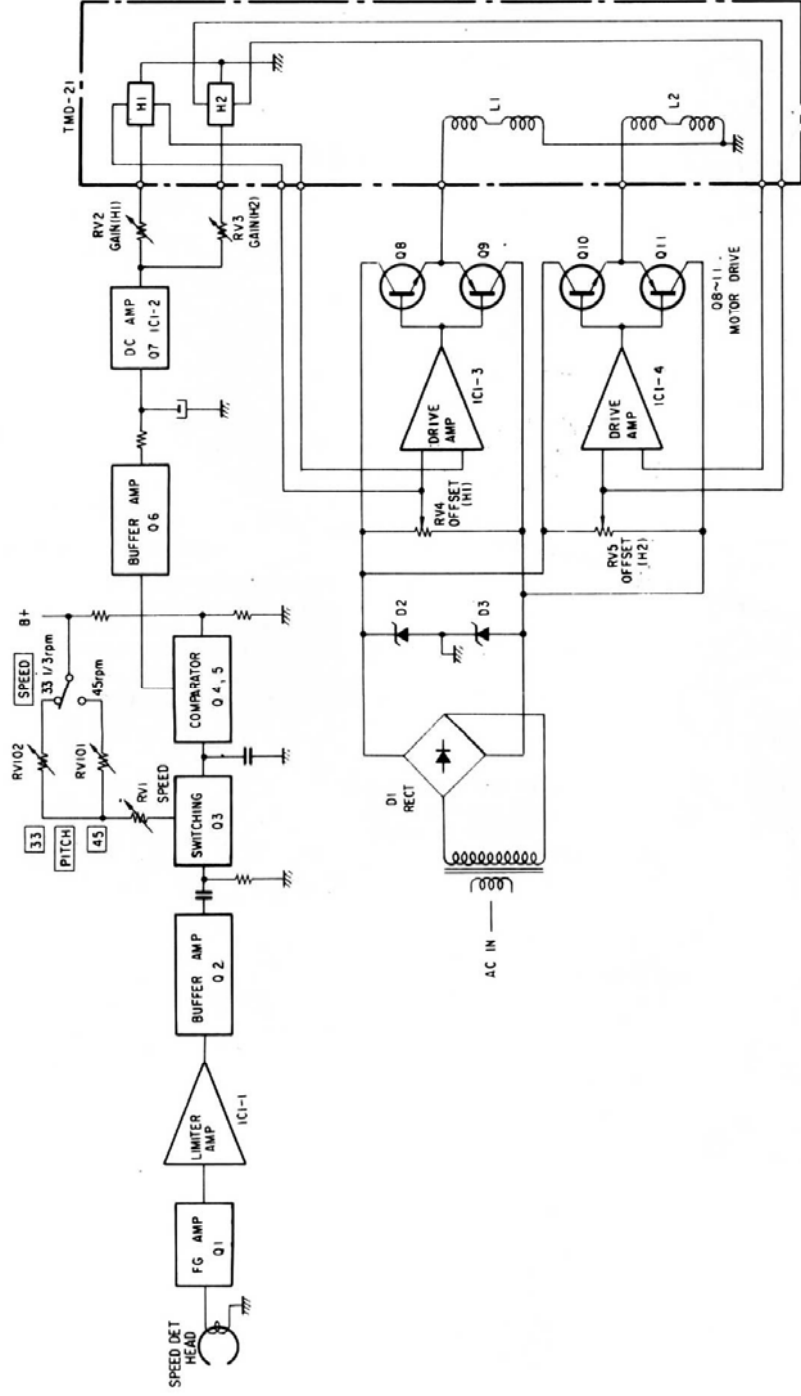

1-2. HALL MOTOR (TMD-21)

Adoption of the BSL (brushless and slotless) DC servo motor has the following major advantages.

- 1) Very little noise due to the elimination of mechanical contacts, and current control by electronic switching.
- 2) Stable performance and very long operational life.

The operating principles of the Hall Motor (TMD-21) are described below.

● Hall Element (VHE-510)

The magnetic field strength is converted into electrical signals by employing the Hall Effect *

- * The Hall Effect: When a current (I) flows through a substance, and a magnetic field (B) is applied at right angles to the direction of current flow, a potential difference (V) will be generated in a direction at right angles to both the current and magnetic field. (See Fig. 1-1.)

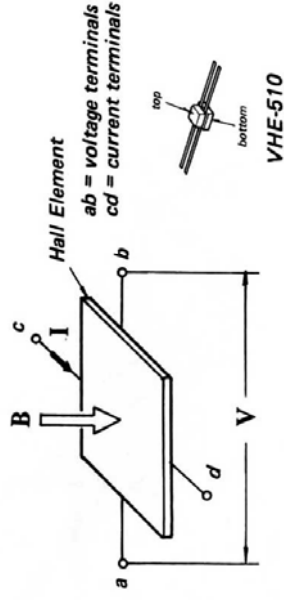

Fig. 1-1.

Note: There is no distinction between voltage and current terminals in the VHE-510 Hall Element.

● **Motor Drive**

The TMD-21 Hall Motor employs the Hall Element to detect the position of magnets. When an N pole is positioned opposite the Hall Element H1 in Fig. 1-2, a positive voltage is generated in H1. This voltage is then amplified in IC1-3, and then applied to Q8 after passing through R31. Once Q8 is turned ON, B+ voltage is applied to L1. The current flowing through L1, and the magnet's magnetic field, produces a magnetic force and rotates the rotor in the direction of the arrow.

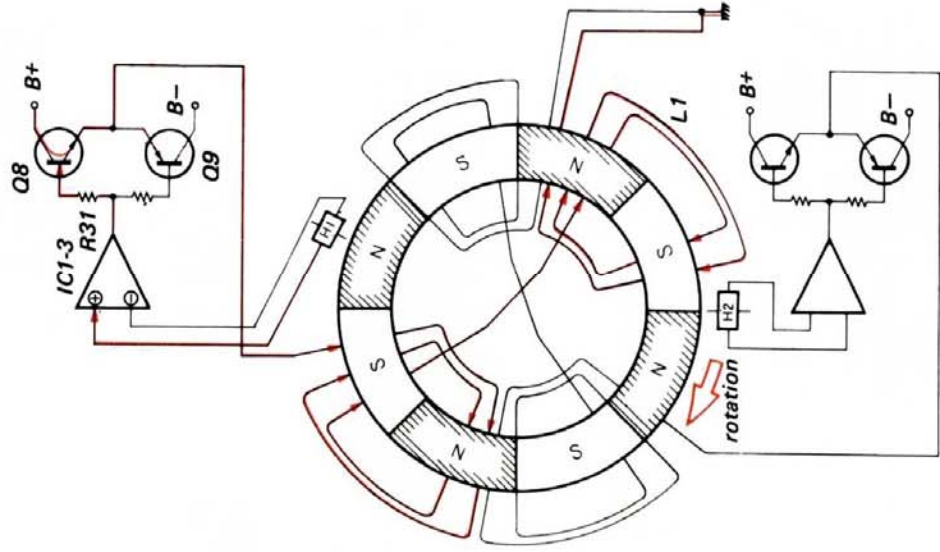

Fig. 1-2.

When the rotor rotates by $22^\circ 30'$, an S pole will be positioned opposite the Hall Element H2 in Fig. 1-3, thus resulting in the generation of a negative voltage in H2. This voltage is amplified by IC1-4, and passed through R36, thus turning Q11 ON, and the resulting in B- voltage being applied to L2. The current flowing through L2, and the magnet's magnetic field, produce a magnetic force, again in the same direction as before.

Therefore, N poles and S poles are repeatedly positioned opposite H1 and H2 Hall Elements respectively every 45° of a rotation, resulting in the generation of the voltages in H1, H2 which are used to produce the force required to rotate the rotor.

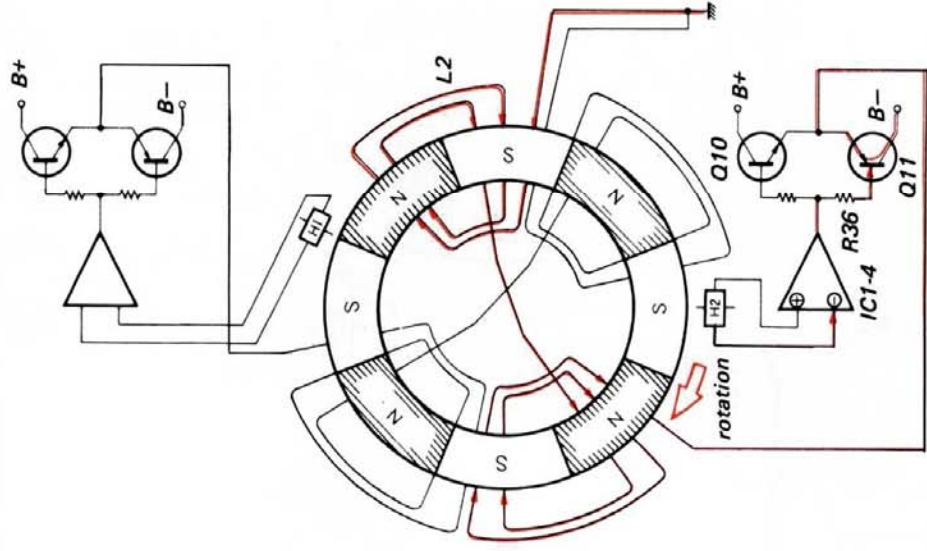

Fig. 1-3.

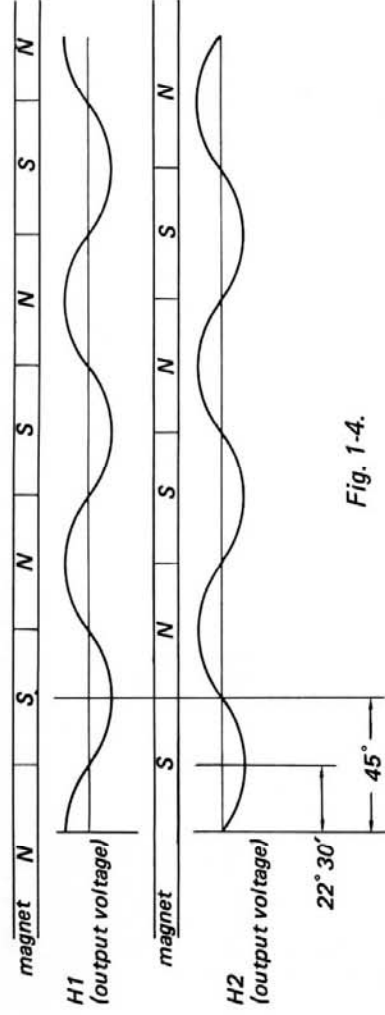
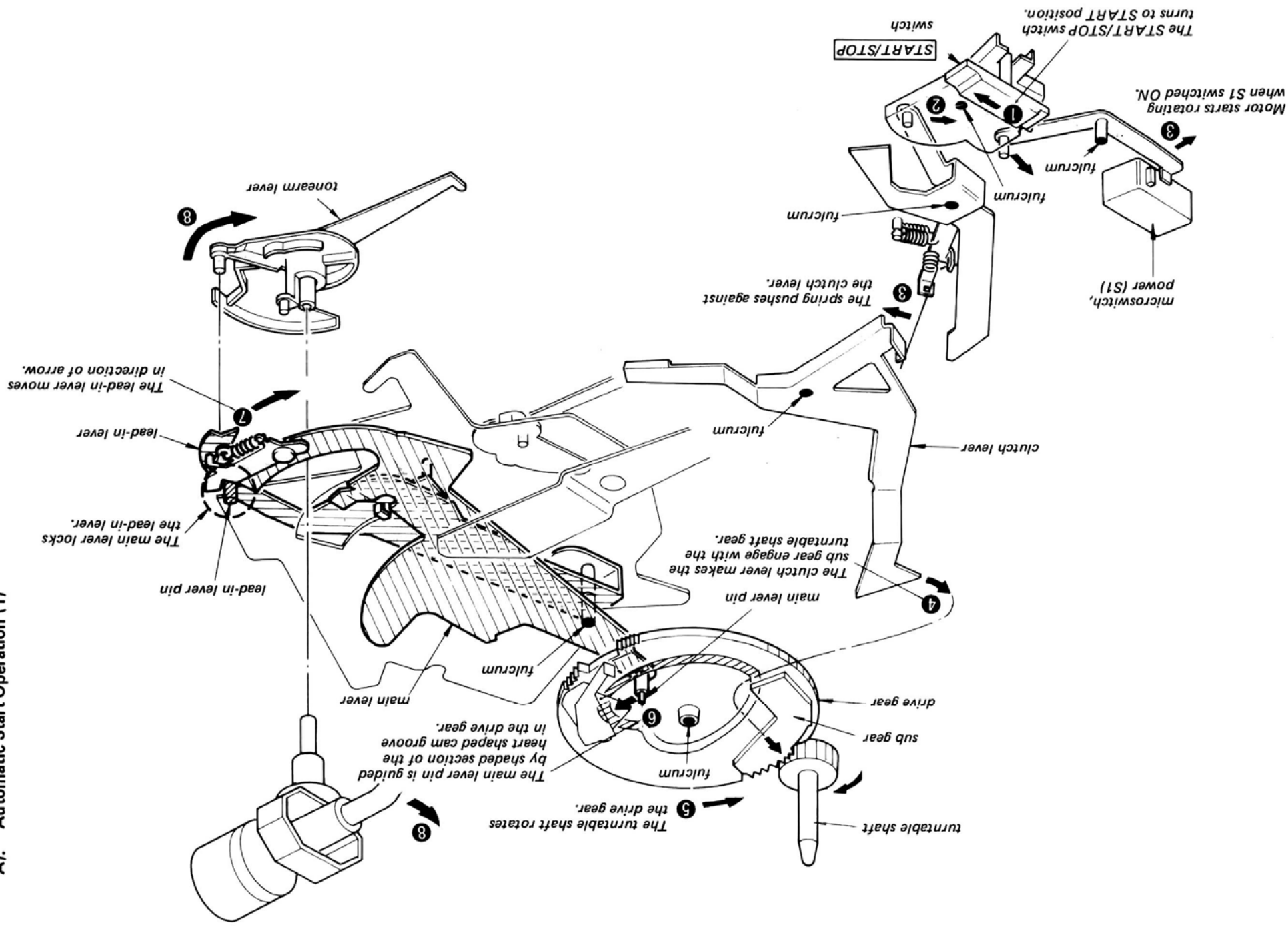

Fig. 1-4.

1-3. MECHANICAL OPERATION

A). Automatic Start Operation (1)



B). Automatic Start Operation (2)

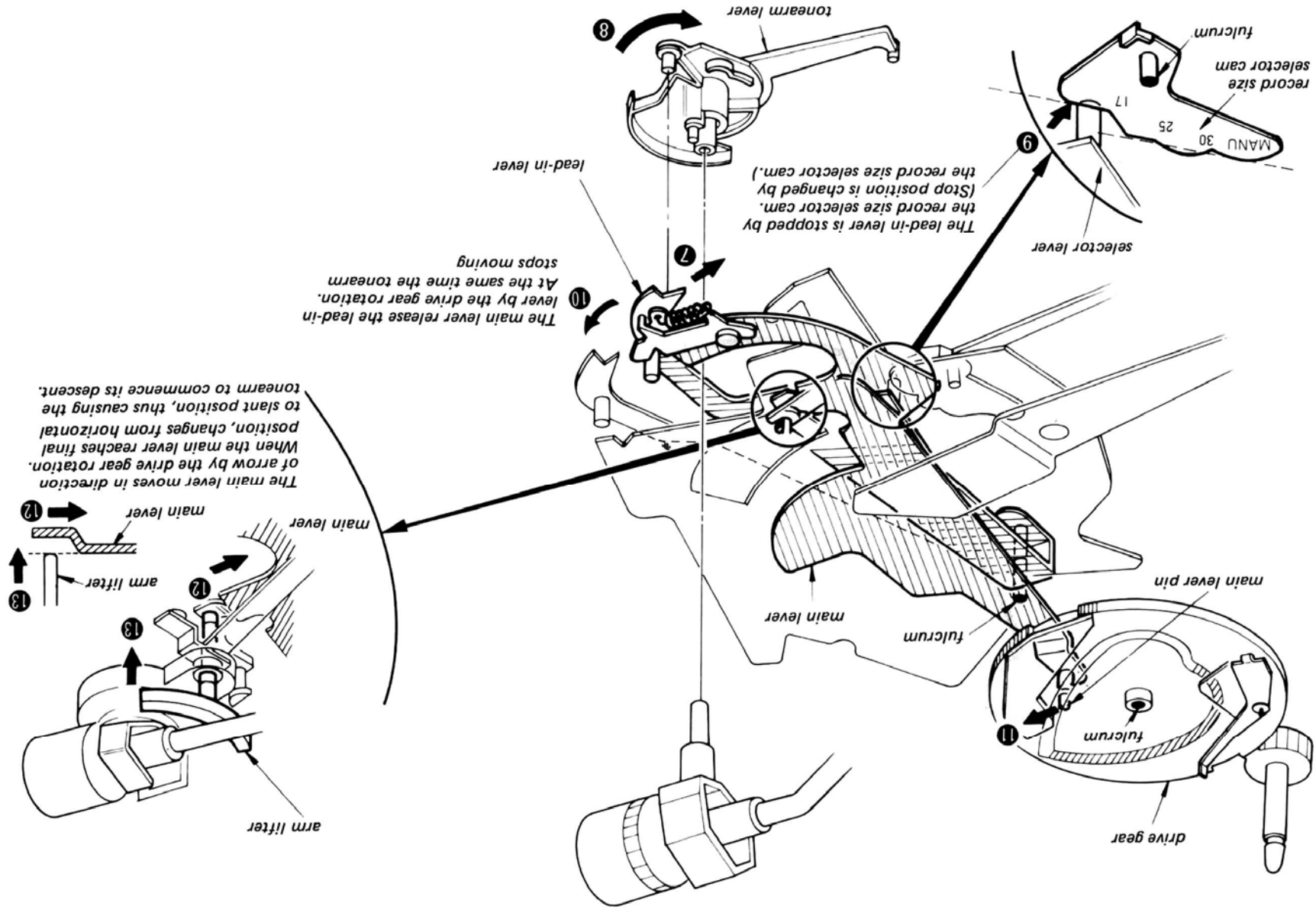

C). Automatic Return Operation

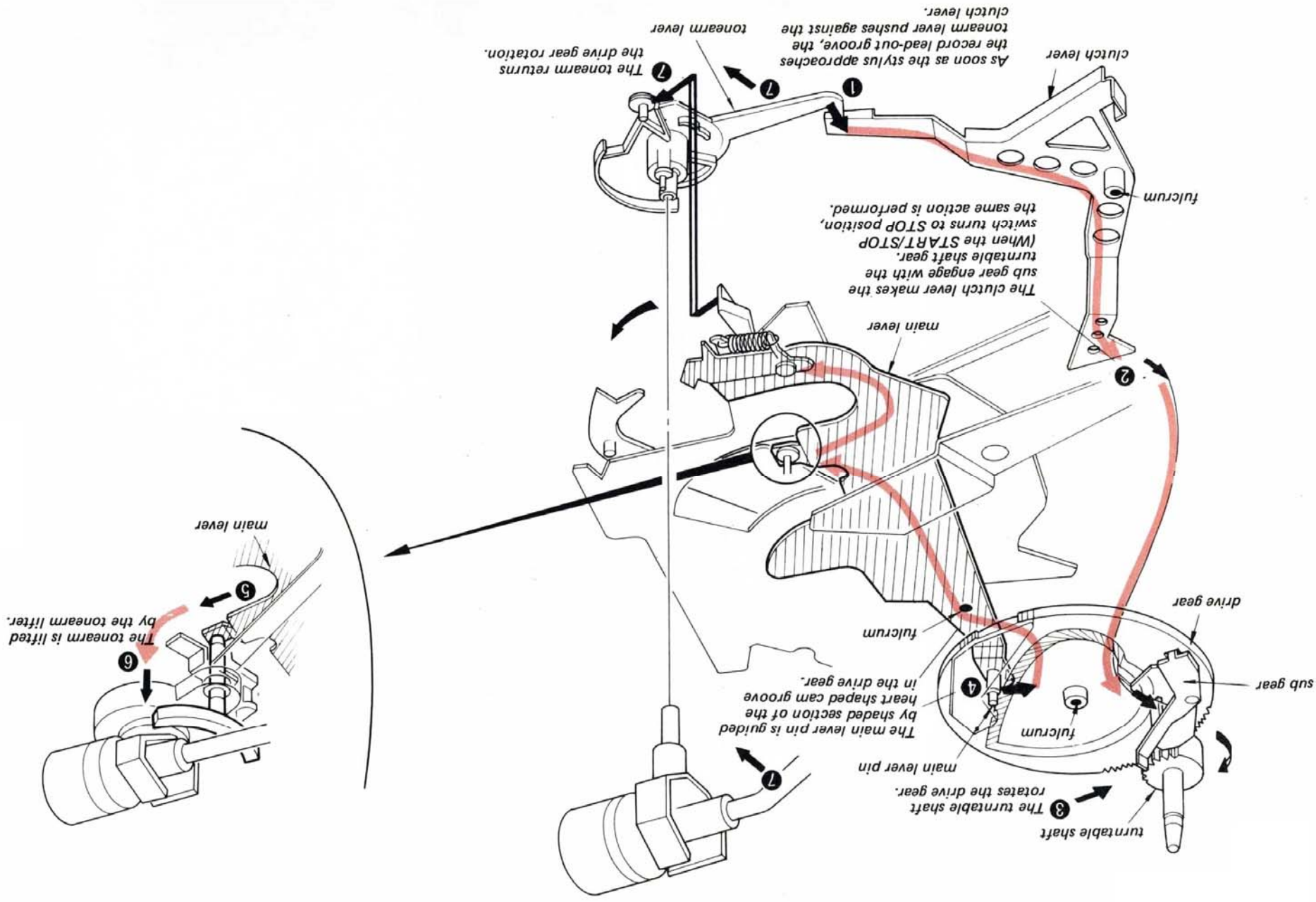

SECTION 2 DISASSEMBLY

2-1. REMOVAL

Turntable Platter

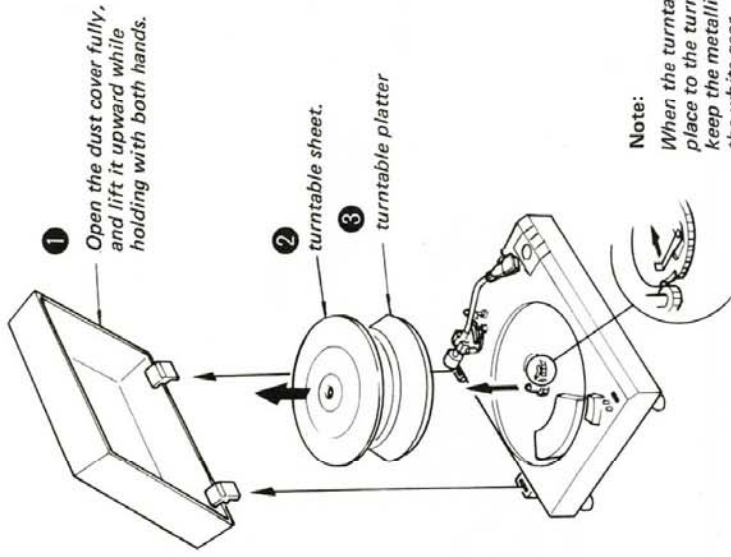

Bottom Case

- 1** Unplug the power cord.
- 2** Secure the tonearm to the arm rest.
- 3** Install the dust cover.
- 4** Remove nine screws (● mark).
- 5** Remove the bottom case.

Note:

※ mark: spare holes
If the screws (● mark) can not be secured,
put them into the spare holes (※ mark).

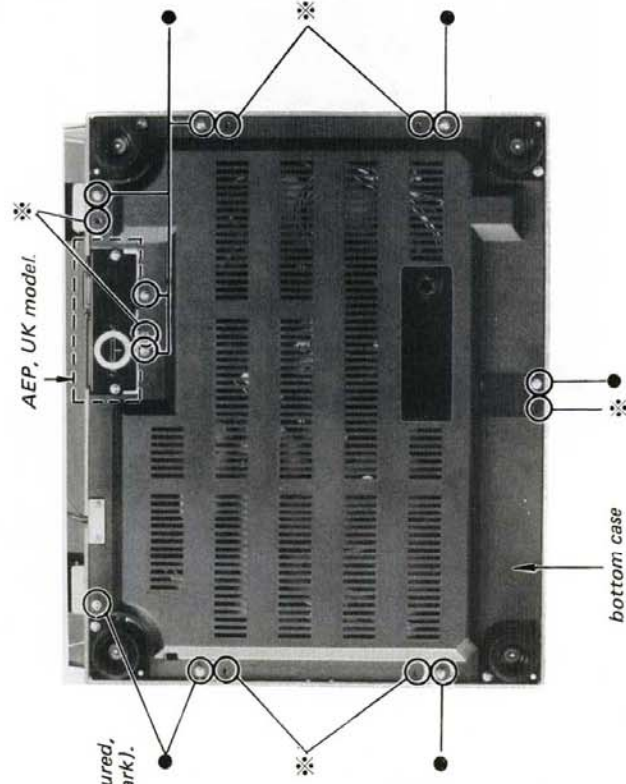

Tonearm

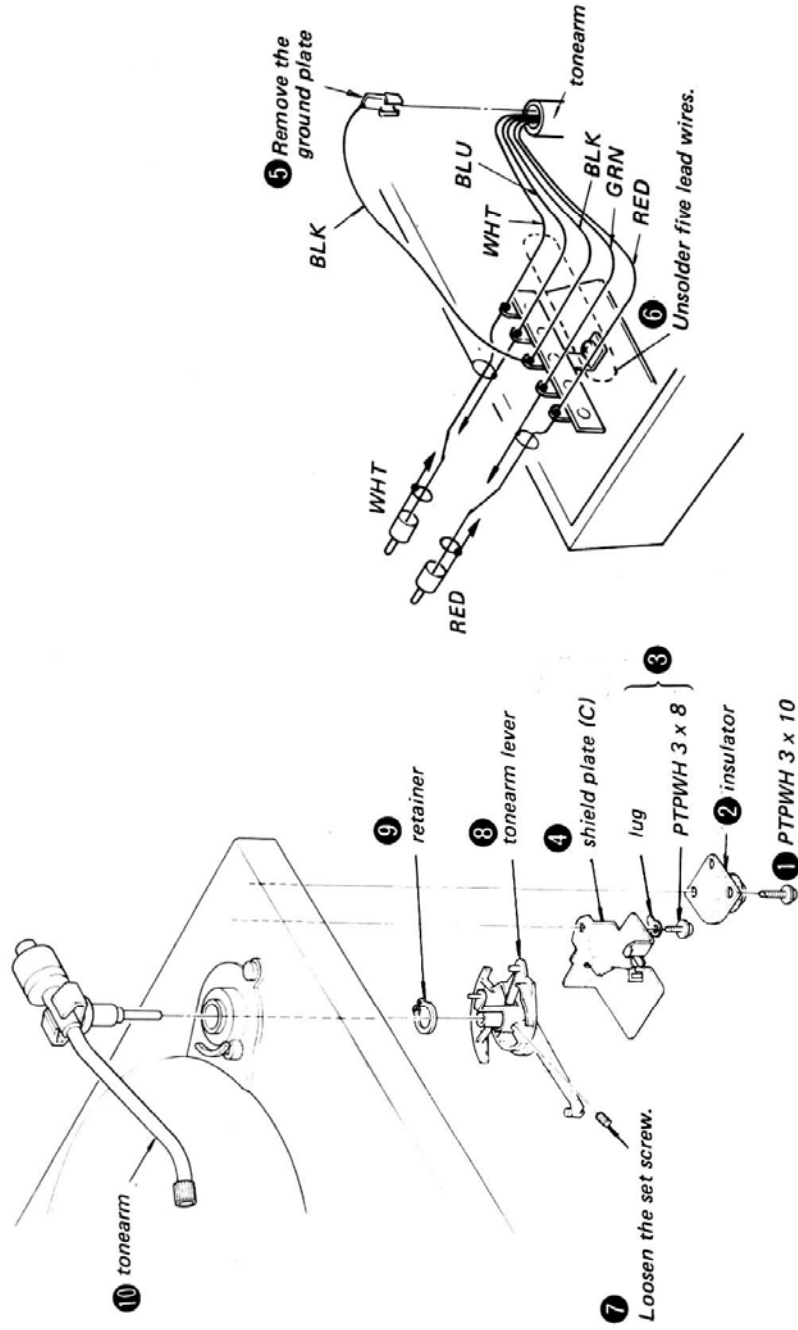

Motor

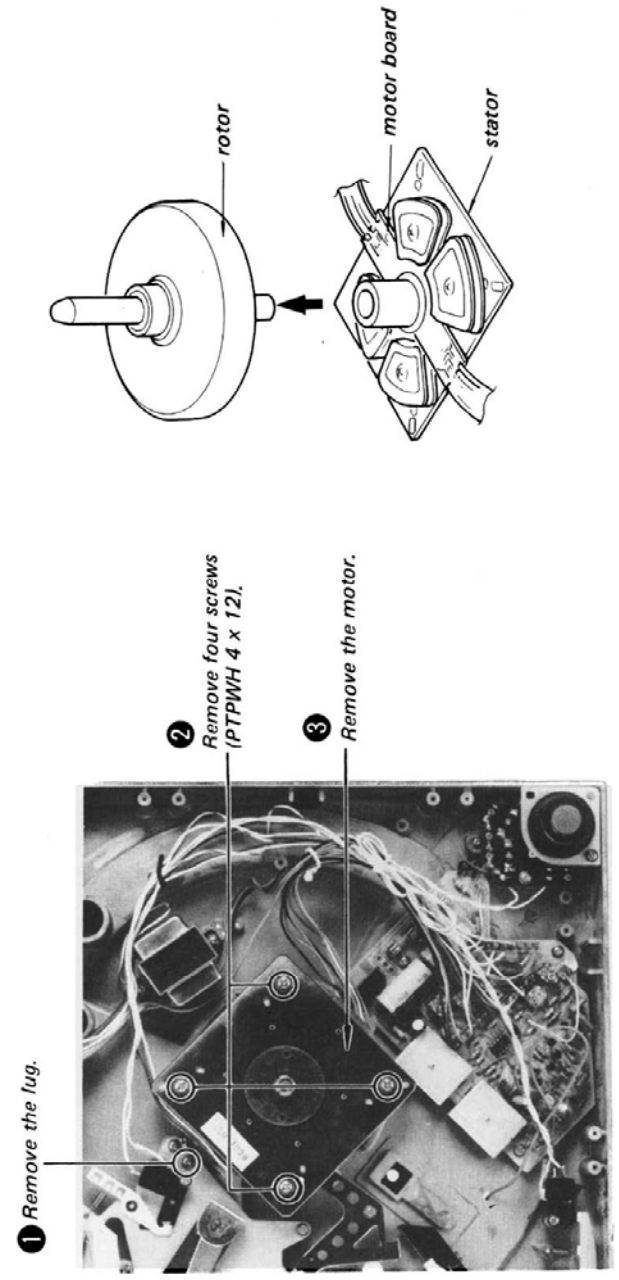

Servo Amp Board

6 Remove the servo amp board.

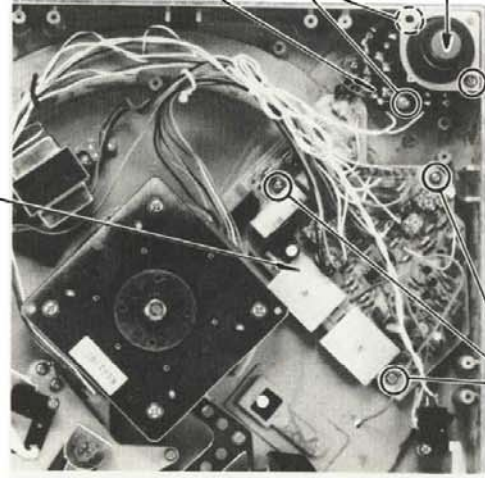

5 PTPWH 3 x 8

1 PTPWH 3 x 8

4

Remove the switch board.

3

PTPWH 3 x 8

2

Remove the insulator

7 Set the servo amp board as shown below.

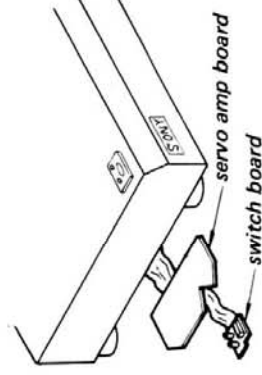

Cartridge Replacement (VL-32G)

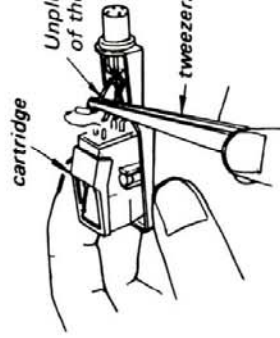

cartridge

Unplug four pin-connectors of the shell.

tweezers

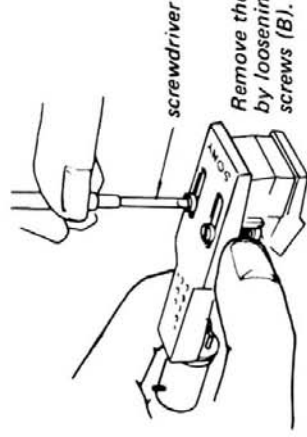

screwdriver

Remove the old cartridge by loosening two mounting screws (B).

- Connection of lead wires. (cartridge)

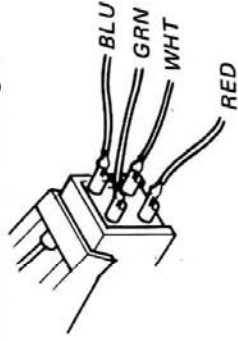

- Connection of lead wires. (head shell)



Fasten the screws lightly so that the cartridge can slide for adjustment.

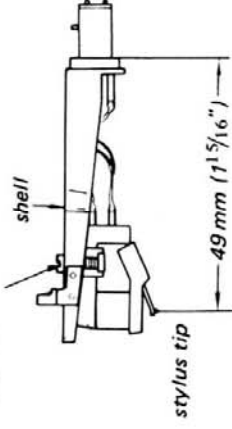

stylus tip

49 mm (1 5/16")

SECTION 3 ADJUSTMENTS

3-1. MECHANICAL ADJUSTMENTS

Tonearm Height Adjustment

A). Automatic Return Operation

1. Bring the tonearm toward the inner of the record and put the stylus in the last groove of the record.
2. Slowly turn the turntable by hand to lift the tonearm.
3. Confirm that the clearance between the stylus tip and the record is 7 - 12 mm as shown in Fig. 3-1. If necessary, adjust the height of the arm lifter by loosening the set screw.
4. After the adjustment, confirm that the tonearm smoothly returns to the tonearm rest as shown in Fig. 3-2.

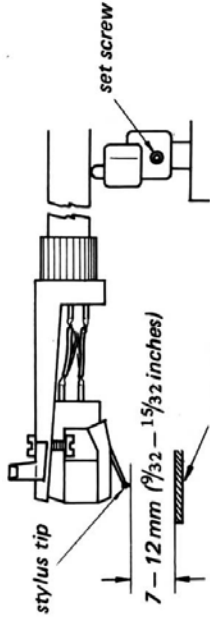

Fig. 3-1.

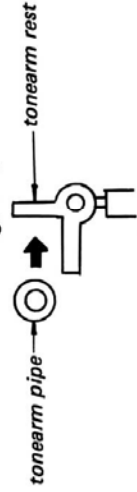

Fig. 3-2.

B). Manual Return Operation

1. Bring the tonearm to the desired position on the record.
2. Lift the cueing lever and confirm that the clearance between the stylus tip and the record is 7 - 12 mm as shown in Fig. 3-1. If necessary, bend the seesaw plate and adjust the height of the tonearm by turning the adjustment screw.

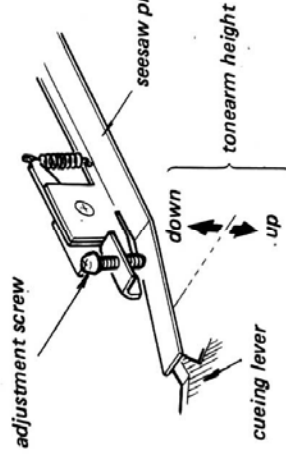

Fig. 3-3.

Automatic Return Position Adjustment

1. If the automatic return operation does not work properly, adjust by turning the adjustment screw as shown in Fig. 3-5.

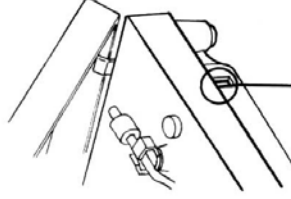

Fig. 3-4.

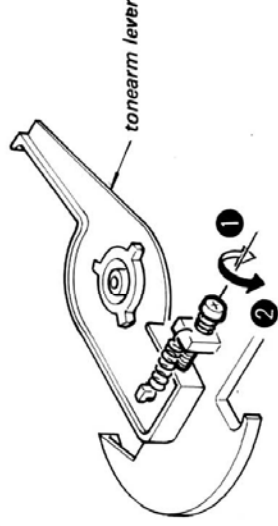
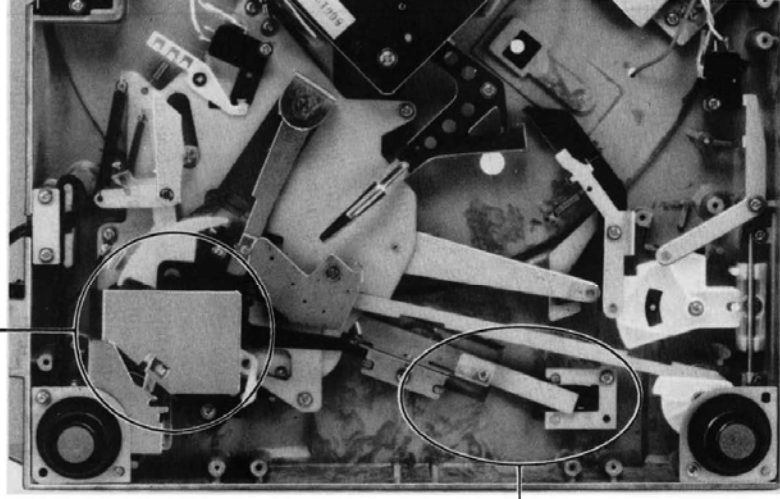

Fig. 3-5.



Brake Drum Position Adjustment

1. Secure the tonearm to the arm rest.
2. Adjust the position of the brake drum by loosening the set screw as shown in Fig. 3-6.

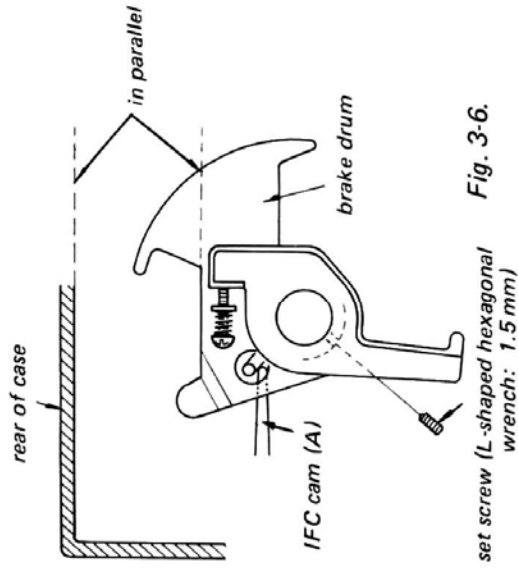

Fig. 3-6.

Brake Lever Position Adjustment

1. Rotate the drive gear by hand and set the main lever pin to the position **A**.
2. Turn the adjustment screw so that the clearance between the brake drum and the brake lever ass'y is 3 - 4 mm as shown below.
3. Then, turn the adjustment screw counterclockwise about 1/2 turns from the position obtained in step 2.

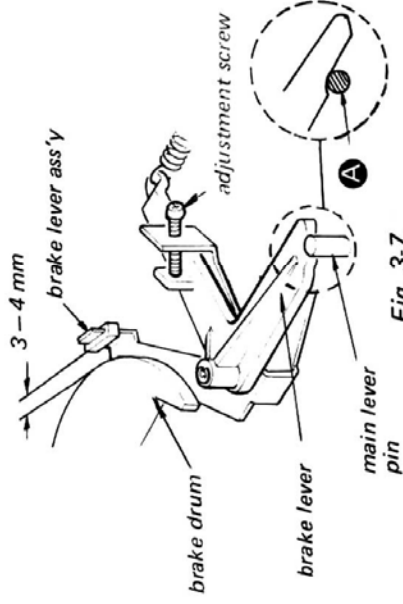

Fig. 3-7.

Tonearm Drop-point Adjustment

1. Bring the tonearm to the arm rest.
2. Start automatic play and confirm that the stylus lowers on a point approx. 1 mm out from the start point of the program.
3. If necessary, remove the rubber cap and turn the adjustment screw so that the stylus lowers on the correct drop point. (See Fig. 3-9.)

Note: Once it is properly adjusted with a 30 cm (12 inches) record, the drop point will be correct for 17 cm (7 inches) and 25 cm (10 inches) records as well.

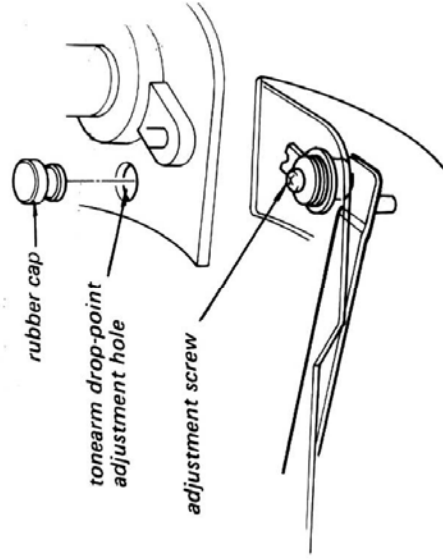
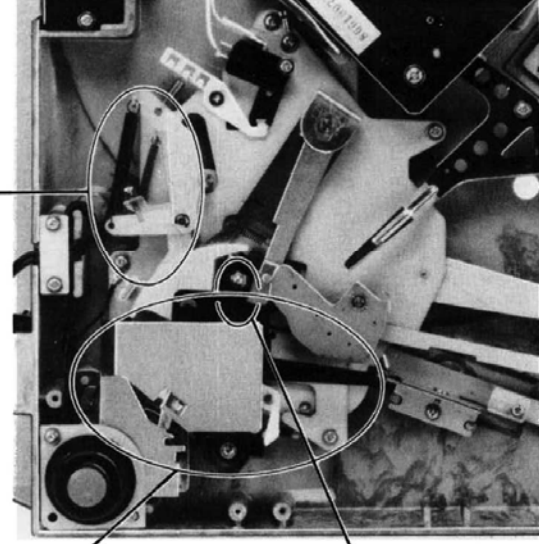

Fig. 3-8.

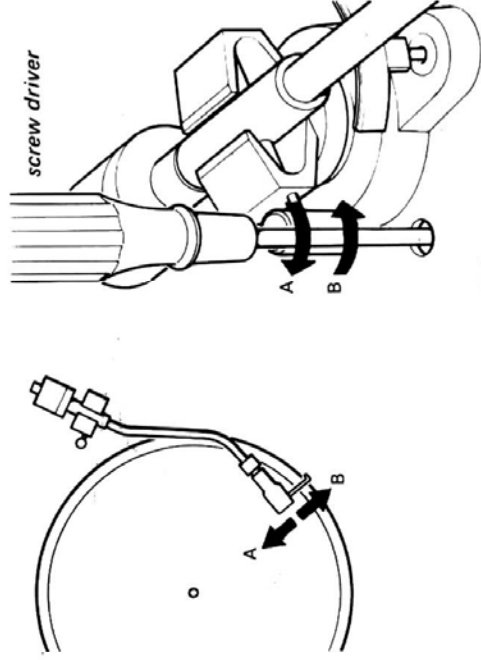
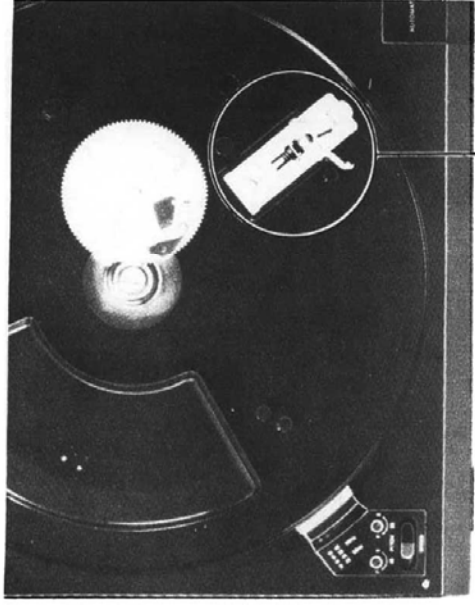

Fig. 3-9.



Speed Detecting Head Position Adjustment

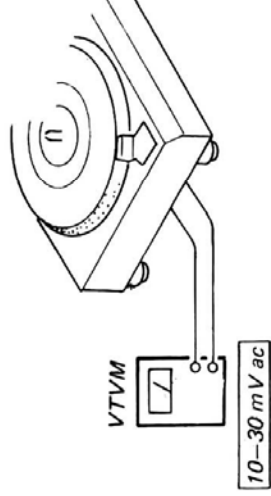
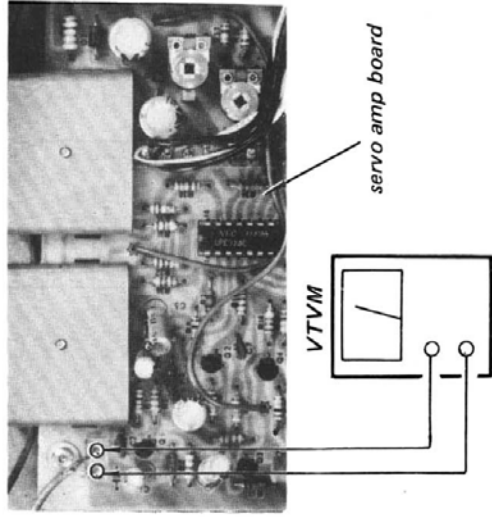

Fig. 3-10.

1. Remove the turntable platter.
2. Set the head deck as shown in Fig. 3-12.
3. Install the turntable platter.
4. Set the SPEED selector switch (S2) to 33 position.
5. Adjust the PITCH control (33) so that the stroboscope pattern appears stationary.
6. Confirm that the VTVM reads 10 - 30 mV ac. If necessary, adjust the position of the head deck by loosening the adjustment screw.

Note: Confirm that the head does not touch the turntable platter.

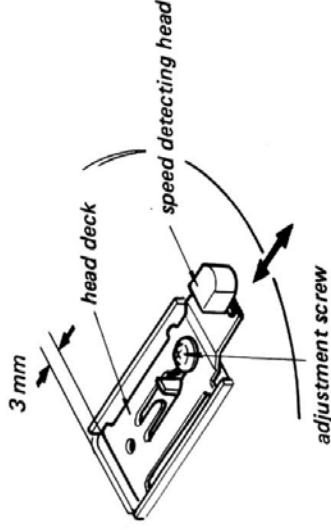

Fig. 3-12.

3-2. ELECTRICAL ADJUSTMENTS

Turntable Speed Adjustment

If correct speed cannot be obtained by adjusting the PITCH controls, adjust RV1.

1. Set the two PITCH control knobs (33 and 45) to the mechanical-mid position.
2. Set the SPEED selector switch to "33" or "45" position and adjust RV1 so that the stroboscope pattern appears stationary.

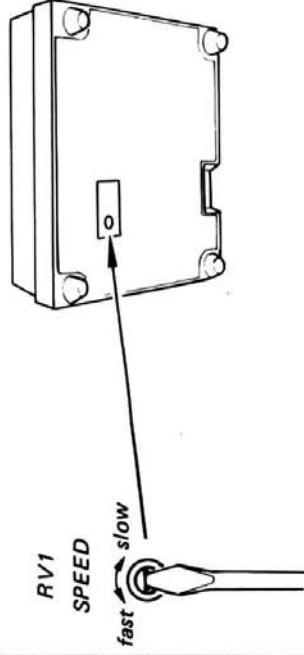

• Motor Gain Adjustment

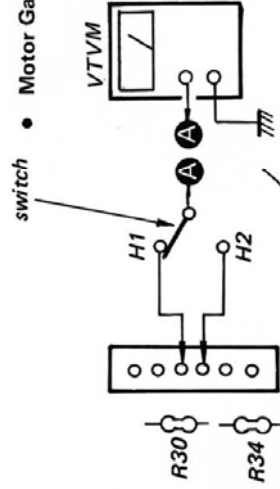

• Offset Adjustment

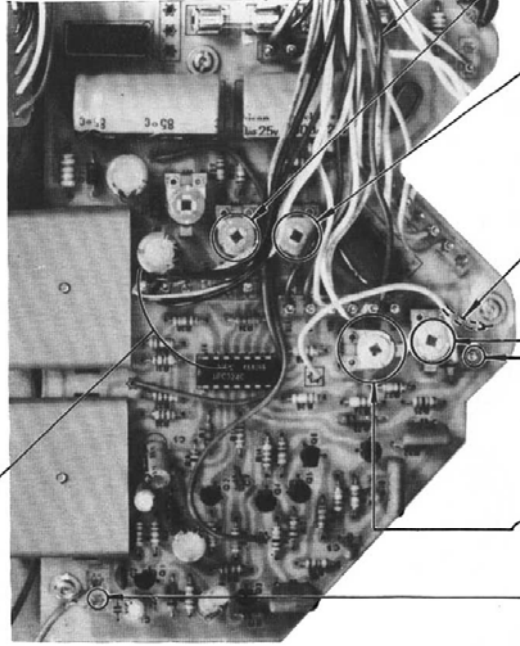
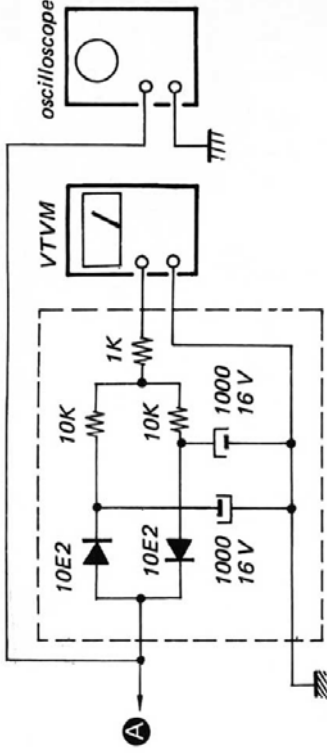

Setting:

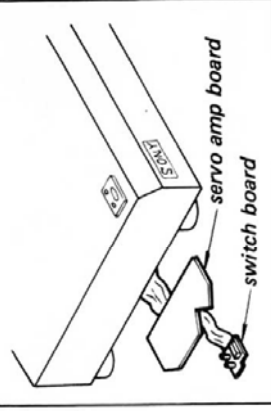

regulated power supply

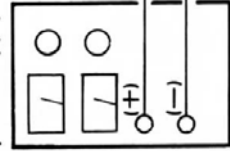

RV2 (H1)

RV3 (H2)

RV5 (H2)

RV4 (H1)

servo amp board

switch

Motor Gain Adjustment

1. Turn the switch to H1 position and adjust RV2 for 2.3 V ac VTVM reading.
2. Turn the switch to H2 position and adjust RV3 for 2.3 V ac VTVM reading.

Offset Adjustment

Note: Offset means the unbalanced voltages of the hall element and IC. When the offset voltage has changed, it causes the wow and flutter.

1. Turn the switch to H1 position and adjust RV4 for 0 V dc VTVM reading or the waveform on oscilloscope shown below.
2. Turn the switch to H2 position and adjust RV5 for 0 V dc VTVM reading or the waveform on oscilloscope shown below.

Waveform on oscilloscope

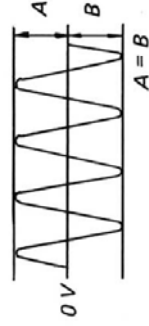

SECTION 4 DIAGRAMS

4-1. MOUNTING DIAGRAMS — Conductor Side —

- Replacement Semiconductors
For replacement, use semiconductors except in ().

Q1 - 5, 7: 2SC634A (2SC945)

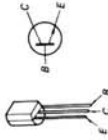

Q6: 2SA678 (2SA733)

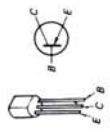

Q8, 10: 2SC1061 (2SC1419)



Q9, 11: 2SA671 (2SA755)

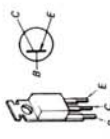

D1: SIRB10

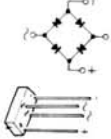

D2, 3: EQB01-13 (EQA01-13R) D4: 1S1555



IC1: μ PC324C

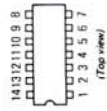

H1, 2: VHE-510



- Note:
- Color code of sleeving over the end of the jacket.

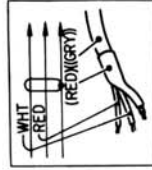

- ■ : part mounted on the conductor side.
- ■ : B+ pattern
- ■ : B- pattern
- Voltages are dc with respect to ground unless otherwise noted.
- Readings are taken with a VOM (20 k Ω /V).
- SPEED selector switch: 33 $\frac{1}{3}$ rpm.

A B C

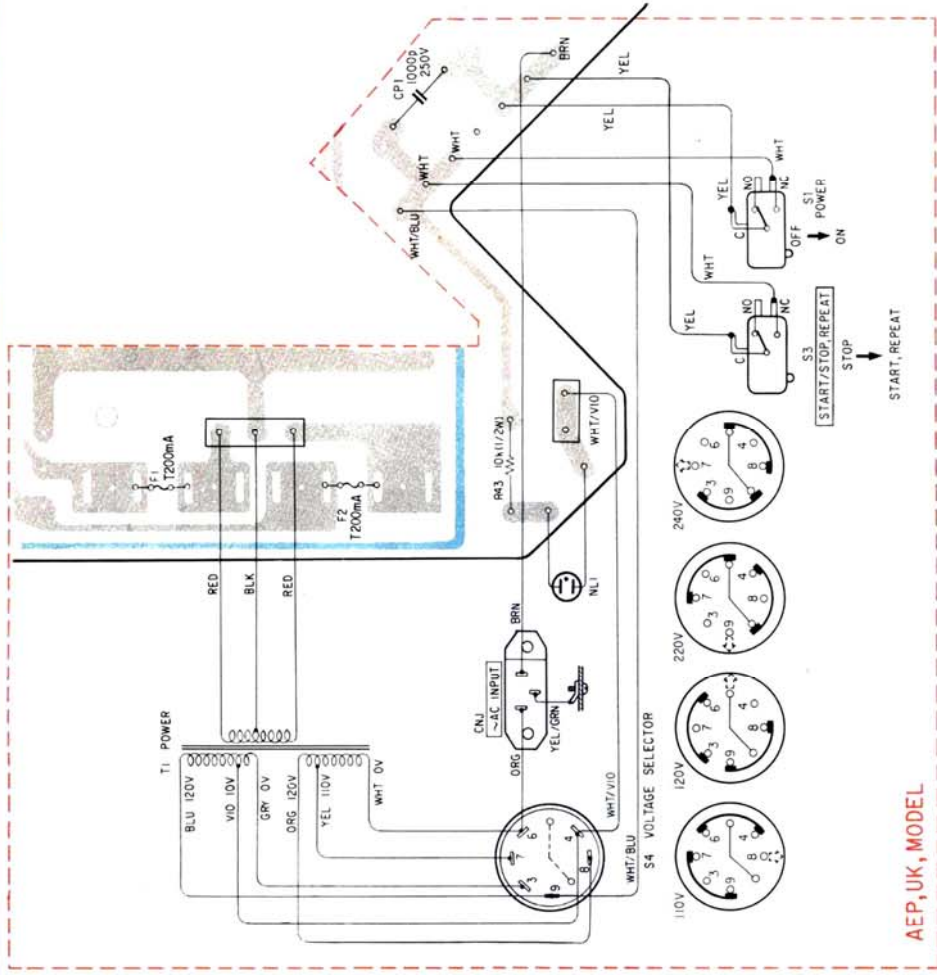

AEP, UK, MODEL

— WAVE FORMS OF IC1 —

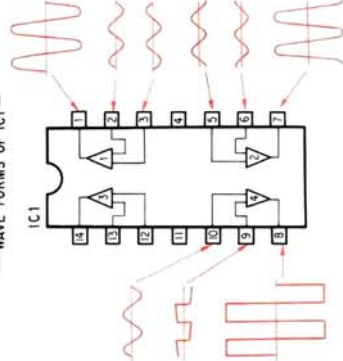

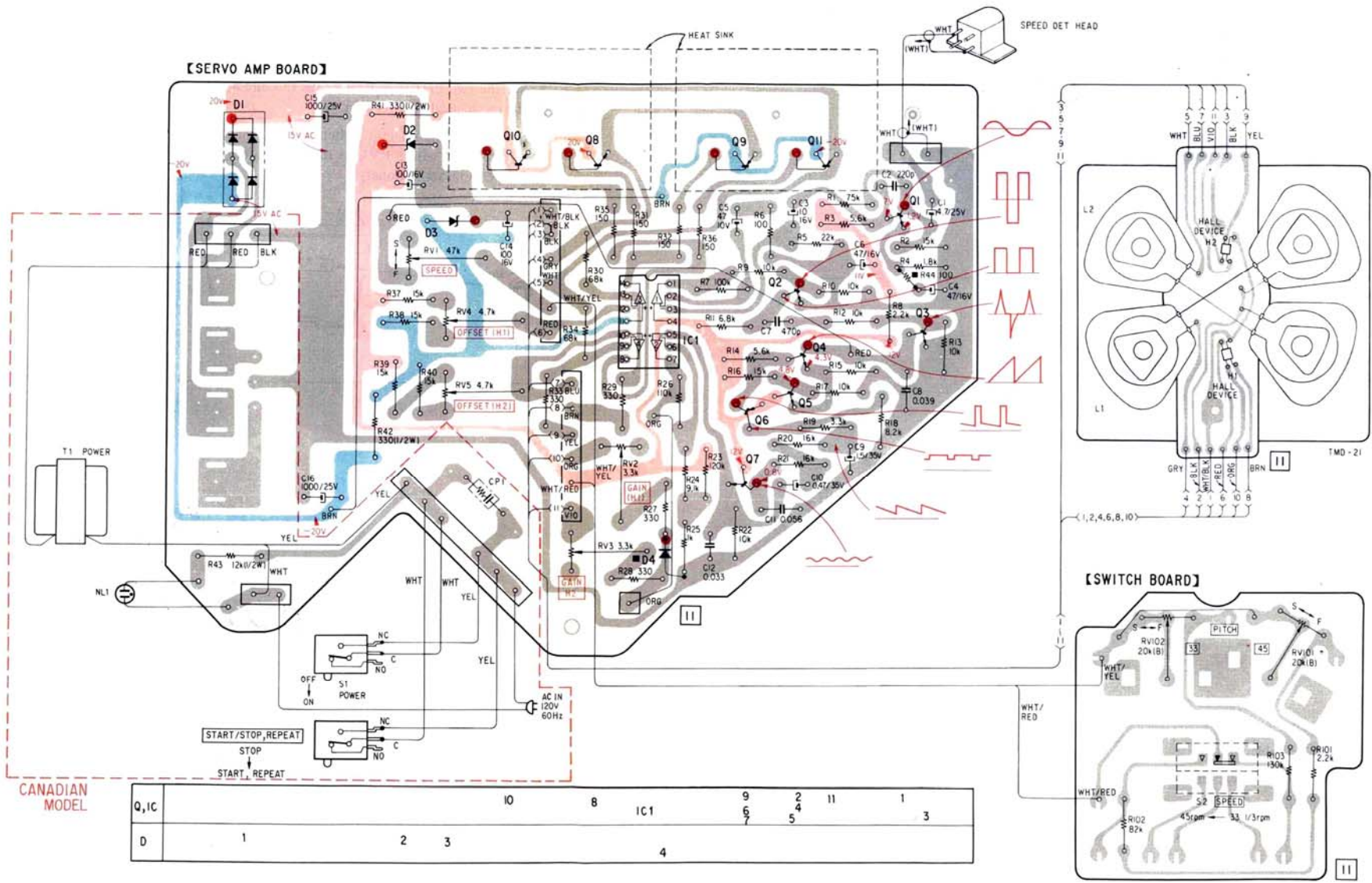

1

2

3

4

4-2. SCHEMATIC DIAGRAM

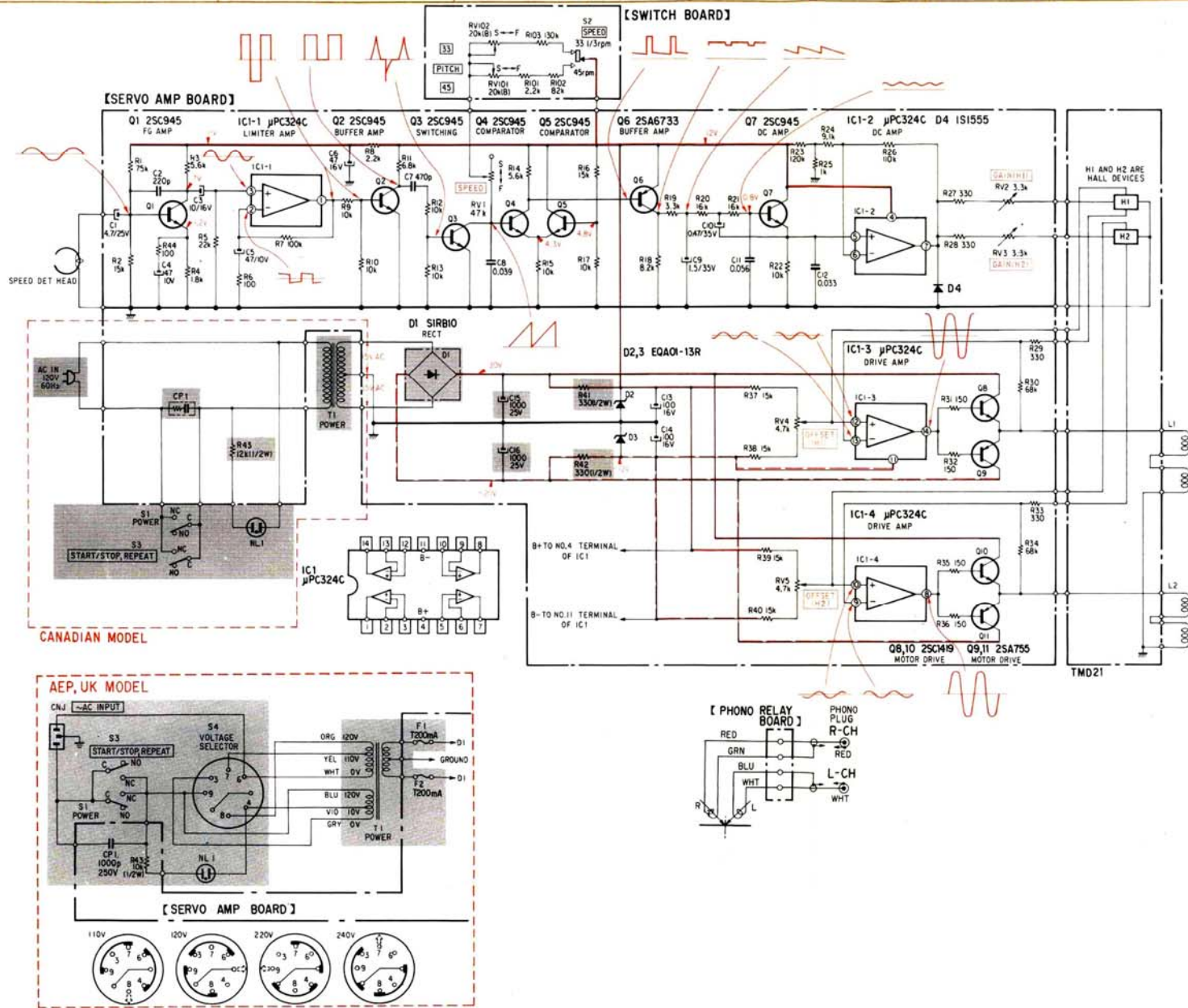

- Note:
- All capacitors are in μF unless otherwise noted. $\text{pF} = \mu\mu\text{F}$. 50 WV or less are not indicated except for electrolytics.
 - All resistors are in ohms, $\frac{1}{2}\text{W}$ unless otherwise noted. $\text{k}\Omega = 1000\ \Omega$, $\text{M}\Omega = 1000\ \text{k}\Omega$
 - : panel designation.
 - : adjustment for repair.
 - Voltages are dc with respect to ground unless otherwise noted.
 - Readings are taken with a VOM (20 $\text{k}\Omega/\text{V}$).
SPEED selector switch: 33 $\frac{1}{3}$ rpm.
 - —: B+ bus.
 - —: B- bus.
 - Switch

Ref. No.	Switch	Position
S1	POWER	OFF
S2	SPEED	33 $\frac{1}{3}$ rpm
S3	START/STOP, REPEAT	STOP
S4	VOLTAGE SELECTOR	—

Note: The components identified by shading are critical for safety. Replace only with part number specified.

5-2.

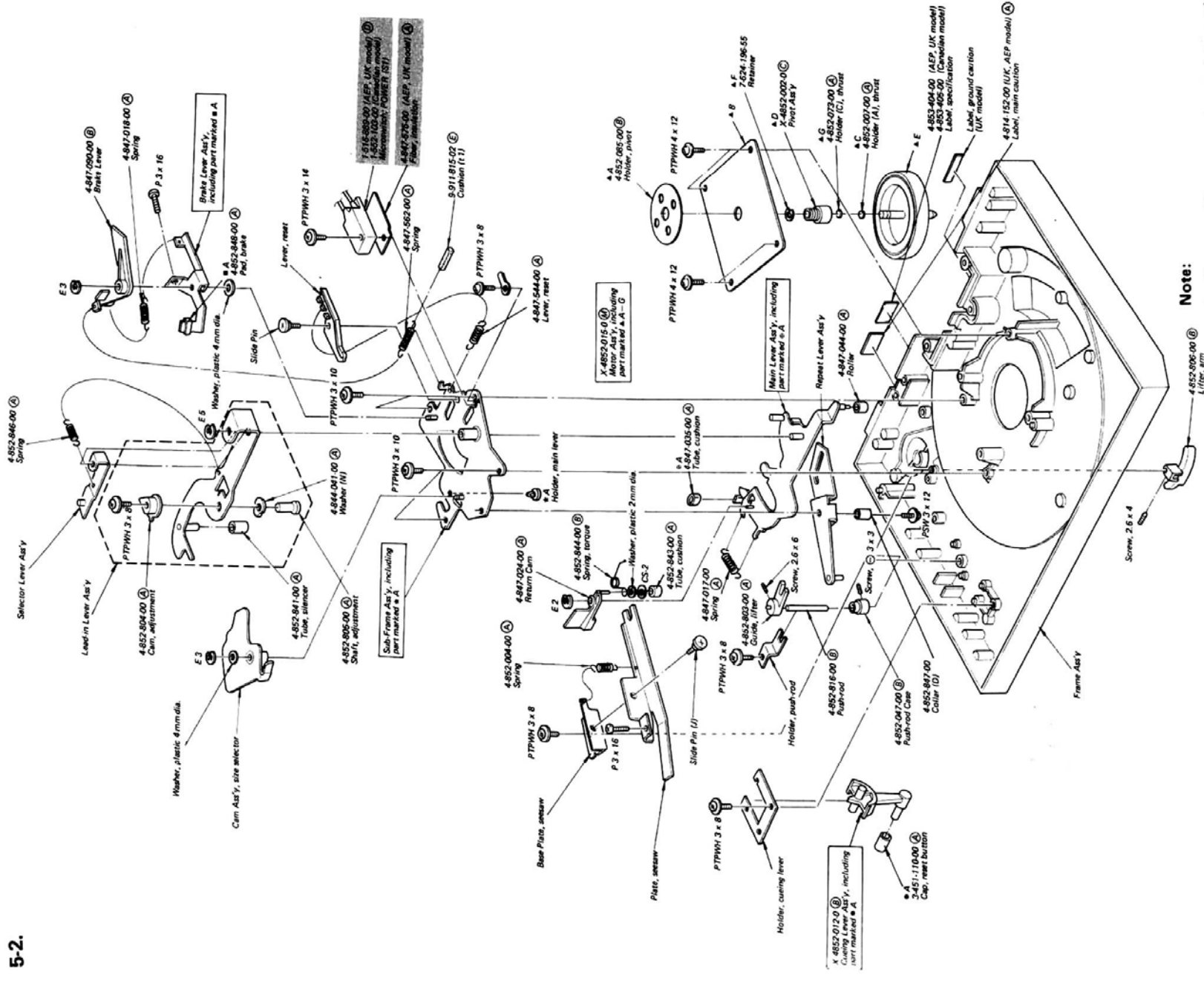

Note:

- Items with no part number and/or no description are not stocked because they are seldom required for routine service.
- All screws are Phillips (cross recess) type unless otherwise noted.
- Circled letters (A) to (Z) are applicable to European models only.

Note: The components identified by shading are critical for safety. Replace only with part number specified.

5-3.

1

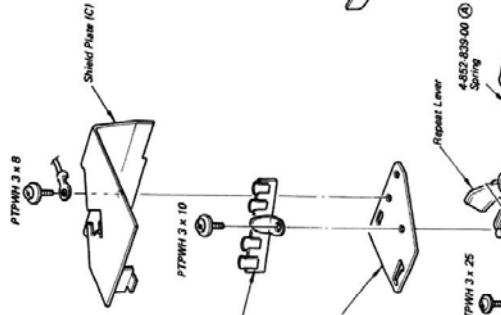

2

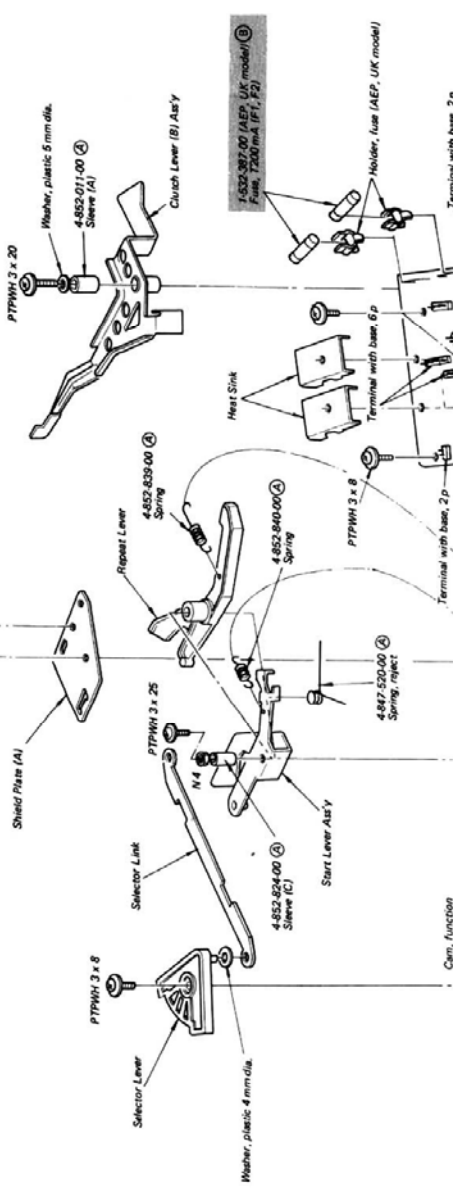

3

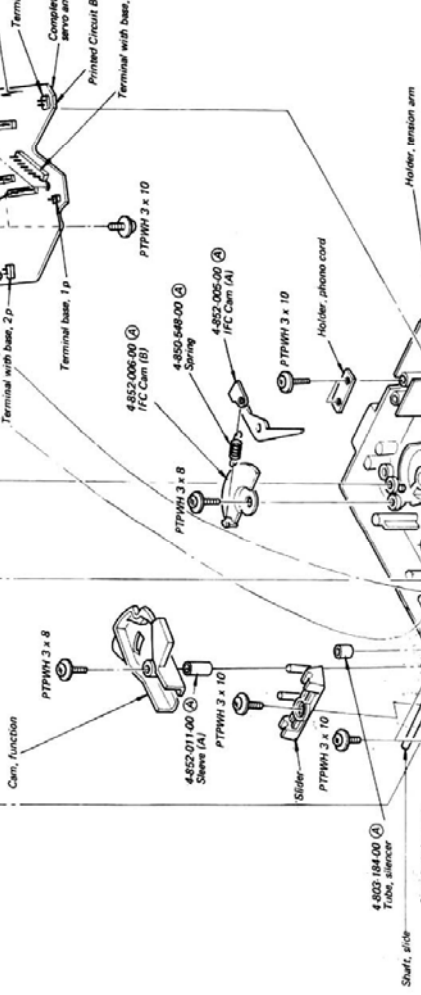

4

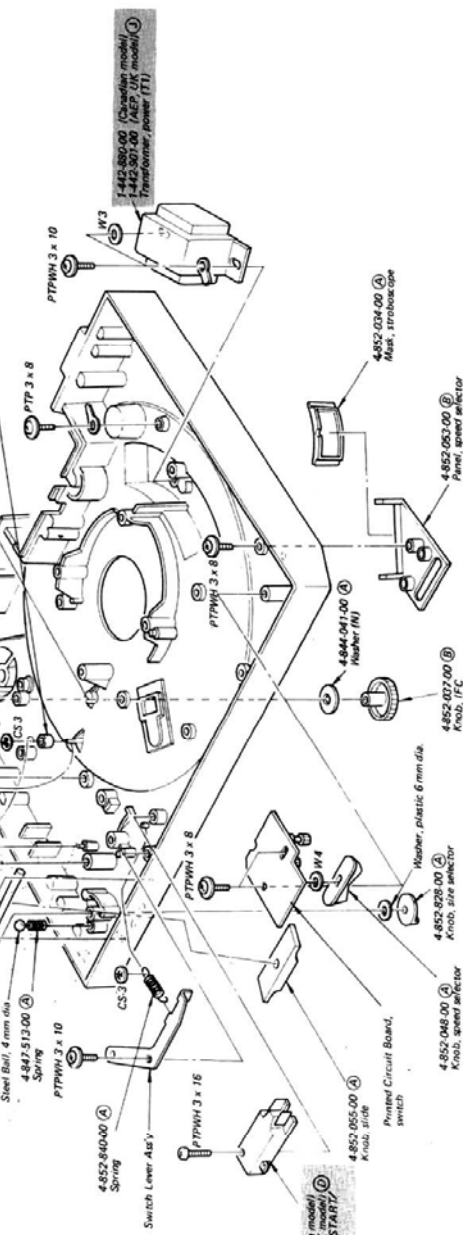

5

Note: The components identified by shading are critical for safety. Replace only with part number specified.

Note:

- Items with no part number and/or no description are not stocked because they are seldom required for routine service.
- All screws are Phillips (cross recess) type unless otherwise noted.
(-) = slotted head
- Circled letters (A) to (Z) are applicable to European models only.

5-4.

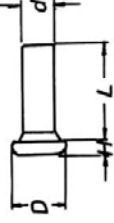
Pan-head screw	
	
Part No.	7-627-553-63
Description	P 2 x 5
d	2 mm
L	5 mm
H	0.6 mm
D	3 mm

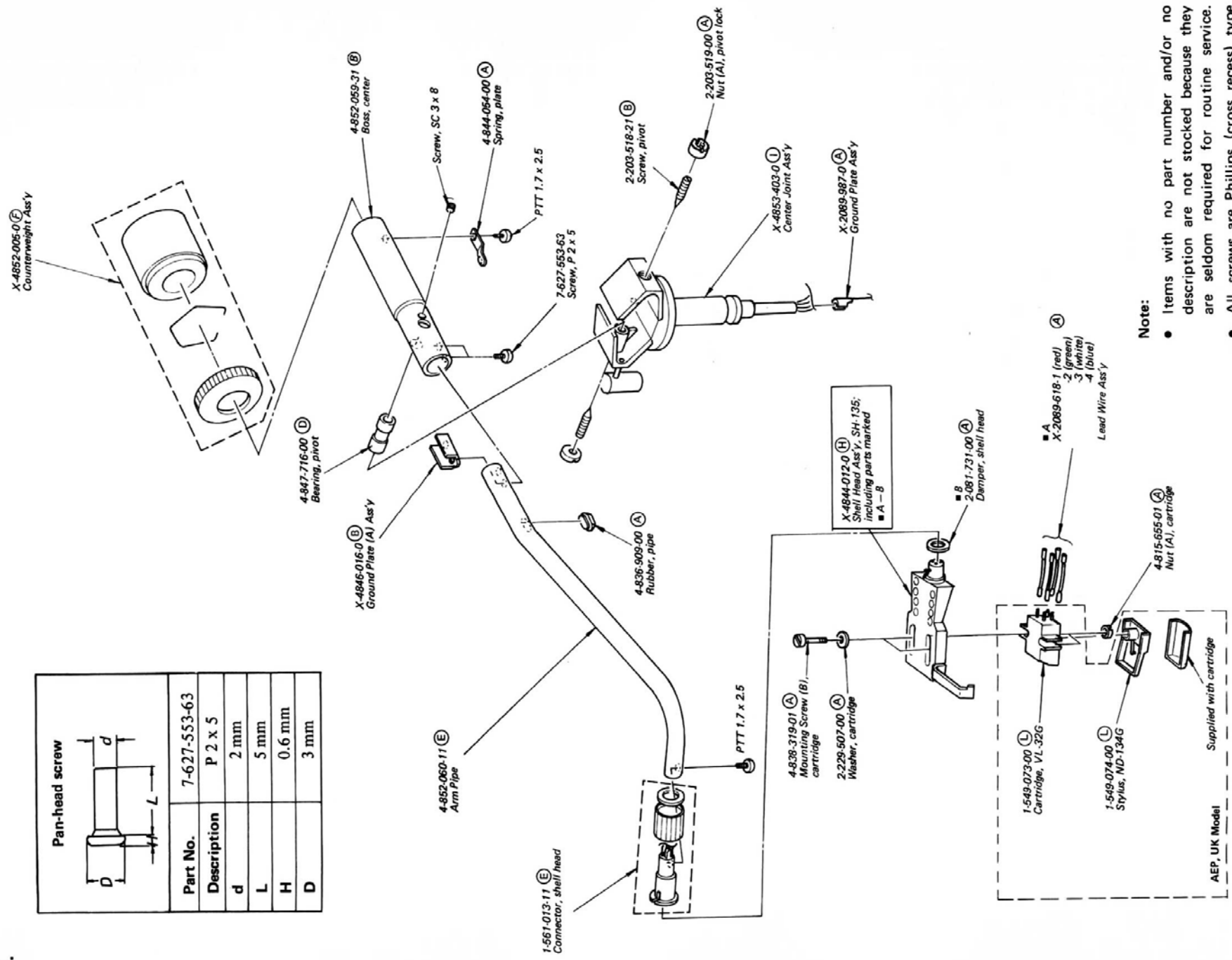

Note:

- Items with no part number and/or no description are not stocked because they are seldom required for routine service.
- All screws are Phillips (cross recess) type unless otherwise noted.
- Circled letters (A) to (Z) are applicable to European models only.

SECTION 6

ELECTRICAL PARTS LIST

Note: Circled letters (**A** to **Z**) are applicable to European models only.

Ref. No.	Part No.	Description
SEMICONDUCTORS		
Transistors		
⇒ Q1 - 5	(B) 2SC634A	
⇒ Q6	(C) 2SA678	
⇒ Q7	(B) 2SC634A	
⇒ Q8	(D) 2SC1061	
⇒ Q9	(E) 2SA671	
⇒ Q10	(D) 2SC1061	
⇒ Q11	(E) 2SA671	

IC1	(G) μ PC324C	
Diodes		
D1	(C) 51RB10	
⇒ D2, 3	(B) EQB01-13	
D4	(B) 1S1555	

Hall Element		
H1, 2	(D) VHE-510	

TRANSFORMERS		
T1	1-442-880-00 Power (Canadian model) 1-442-901-00 (J) Power (AEP, UK model)	

CAPACITORS		
All capacitors are in μ F and ceramic unless otherwise noted. 50WV or less are not indicated except for electrolytics. pF = μ F, elect = electrolytic		
C1	1-121-395-11 (A) 4.7	25 V elect
C2	1-102-110-11 (A) 220 p	
C3	1-121-651-11 (A) 10	16 V elect
C4, 5	1-121-352-11 (A) 47	10 V elect
C6	1-121-409-11 (A) 47	16 V elect
C7	1-102-114-11 (A) 470 p	
C8	1-108-811-12 (B) 0.039	mylar
C9	1-131-216-11 (B) 1.5	35 V tantalum

⇒: Due to standardization, interchangeable replacements may be substituted for parts specified in the diagrams.

Ref. No.	Part No.	Description
C10	1-131-213-11 (B) 0.47	35 V tantalum
C11	1-108-813-12 (B) 0.056	mylar
C12	1-108-810-12 (B) 0.033	mylar
C13, 14	1-121-415-11 (A) 100	16 V elect
C15, 16	1-121-657-11 (B) 1000	25 V elect

RESISTORS

All resistors are in ohms. Common $\frac{1}{4}$ W carbon resistors are omitted. Check schematic diagram for values.

R41, 42	1-244-861-11 (A) 330	$\frac{1}{2}$ W
R43	1-244-897-11 (A) 10 k	$\frac{1}{2}$ W (AEP, UK model)
	1-244-899-11	1.2 k $\frac{1}{2}$ W (Canadian model)
RV1	1-224-647-XX (B) 47 k	adjustable
⇒ RV2, 3	1-224-644-XX (B) 4.7 k	adjustable
RV4, 5	1-224-644-XX (B) 4.7 k	adjustable
RV101, 102	1-226-062-00 (B) 20 k	variable, PITCH

SWITCHES

S1	1-516-889-00 (D) Micro, power (AEP, UK model) 1-552-103-00 Micro, power (Canadian model)
S2	1-552-123-00 (B) Lever Slide, SPEED
S3	1-516-657-11 Micro, START/STOP, REPEAT (Canadian model) 1-516-889-00 (D) Micro, START/STOP, REPEAT (AEP, UK model)
S4	1-552-026-00 (E) Voltage Selector (AEP, UK model)

MISCELLANEOUS

CNJ	1-509-547-00 (C) Connector, 3-p; AC IN (AEP, UK model)
CPI	1-102-222-21 (A) Capacitor, ceramic; 1000 p 250 V (AEP, UK model)
	1-231-326-00 Encapsulated Component (Canadian model)
FL, 2	1-532-387-00 (B) Fuse, T200 mA (AEP, UK model)
NL1	1-519-135-11 (C) Lamp, neon 1-534-985-XX Cord, power (Canadian model)
1-536-401-XX (A) Terminal Strip	
1-543-093-00 (E) Head, speed detecting	
1-549-073-00 (L) Cartridge, VL-32G (AEP, UK model)	
1-549-074-00 (L) Stylus, ND-134G (AEP, UK model)	
1-551-294-21 (E) Cord, w/phone plug	
1-561-013-11 (E) Connector, shell head	

Note: The components identified by shading are critical for safety. Replace only with part number specified.

Note: Circled letters (A to Z) are applicable to European models only.

ACCESSORIES & PACKING MATERIALS

<u>Part No.</u>	<u>Description</u>	<u>Part No.</u>	<u>Description</u>
X-4844-012-0 including:	(H) Shell Head Ass'y, SH-135	3-701-632-00	(A) Bag, plastic; accessory
2-081-731-00	(A) Dumper, shell head	3-701-634-00	(A) Bag, plastic; turntable platter
X-2089-618-1	(A) Lead Wire Ass'y (red)	3-701-806-01	(A) Adaptor, 45 rpm
X-2089-618-2	(A) Lead Wire Ass'y (green)	3-770-324-11	(E) Manual, instruction (AFP, UK model)
X-2089-618-3	(A) Lead Wire Ass'y (white)	3-770-324-31	Manual, instruction (Canadian model)
X-2089-618-4	(A) Lead Wire Ass'y (blue)	3-793-395-11	(A) Gauge, overhang adjustment
1-534-819-00	(G) Cord, power (UK model)	4-815-655-01	(A) Nut (A), cartridge
2-054-619-00	(A) Spacer, cartridge	4-838-319-01	(A) Mounting screw (B), cartridge
2-054-624-01	Screw (B), cartridge (Canadian model)	4-843-577-00	(A) Sheet, protection; dust cover
2-054-625-00	Screw (C), cartridge (Canadian model)	4-847-092-00	(C) Screwdriver
3-701-438-21	Washer, plastic 2.5 mm dia. (Canadian model)	4-847-314-00	(C) Bag, plastic; set
3-701-613-00	Bag, plastic; screws (Canadian model)	4-852-077-00	(A) Protector, counterweight
3-701-616-00	(A) Bag, plastic; counterweight	4-852-078-00	(B) Holder, turntable platter
3-701-623-00	(A) Bag, plastic; power cord (UK model)	4-852-080-00	(B) Cushion, upper
		4-852-081-00	(B) Cushion, lower
		4-852-204-00	(A) Spacer
		4-853-406-00	(G) Carton

Note: The components identified by shading are critical for safety. Replace only with part number specified.